

6-2019

The Theia Soteria: Alternative Design for Safer Initial Entry During Laparoscopic Procedures

Kayla DuBois

Union College - Schenectady, NY

Patrick Ryan

Union College - Schenectady, NY

Madelyn Joanis

Union College - Schenectady, NY

Follow this and additional works at: <https://digitalworks.union.edu/theses>

 Part of the [Biomaterials Commons](#), [Biomedical Devices and Instrumentation Commons](#), and the [Surgery Commons](#)

Recommended Citation

DuBois, Kayla; Ryan, Patrick; and Joanis, Madelyn, "The Theia Soteria: Alternative Design for Safer Initial Entry During Laparoscopic Procedures" (2019). *Honors Theses*. 2289.

<https://digitalworks.union.edu/theses/2289>

This Open Access is brought to you for free and open access by the Student Work at Union | Digital Works. It has been accepted for inclusion in Honors Theses by an authorized administrator of Union | Digital Works. For more information, please contact digitalworks@union.edu.

The Theia Soteria:
Alternative Design for Safer Initial Entry During Laparoscopic Procedures

By

Kayla DuBois, Madelyn Joanis, Patrick Ryan

Submitted in partial fulfillment
of the requirements for
Honors in the Departments of Biomedical Engineering

UNION COLLEGE

June 2019

ABSTRACT

DUBOIS, KAYLA The Theia Soteria: Alternative Design for Safer Initial Entry During Laparoscopic Procedures

Department of Biomedical Engineering

June 2019

ADVISORS: Jennifer Currey, Takashi Buma, and Shane Cotter

Laparoscopic procedures account for 15 million surgeries worldwide [1], with the initial entry into the peritoneal cavity accounting for 33-50% of all major laparoscopic complications [7]. This initial entry is the most dangerous as surgeons must enter the cavity using a sharp object with no visibility and space between the outer surface of the cavity and internal tissues. During the initial entry into the peritoneal cavity, the patients undergoing laparoscopic procedures are at a high risk for damage to internal organs and vasculature, necessitating the development of a device to protect these internal tissues and increase patient safety.

Table of Contents

Background.....	1
Problem Statement.....	4
Design Objectives.....	5
Device Functions and Specifications.....	6
Design Requirements.....	8
Proposed Design.....	11
Entry and Insufflation.....	11
Retraction of Stylet Prior to Entry.....	12
Removal of Needle.....	13
Final Prototype.....	14
Validation of Design.....	14
Anticipated Regulatory Pathway.....	17
References.....	19
Appendix A: Current Patents.....	A-1
Appendix B: Objective and Sub-Objective Trees.....	B-1
Appendix C: Decision Matrices.....	C-1
Appendix D: Other Designs Not Developed Further.....	D-1

Background

Laparoscopic procedures account for 15 million surgeries worldwide and are becoming the new standard for abdominal surgeries, such as cholecystectomies, appendectomies, tubo-ovarian procedures, hysterectomies, bariatric procedures, gastrointestinal procedures, urological cancer resections, and aortic aneurysms [1]. Laparoscopic procedures are preferred to their open procedure counterparts because they provide greater intraoperative visibility, are less expensive, and are less invasive, leading to patients experiencing less pain, a shorter recovery time, less scarring, reduced blood loss, and a shorter stay in the hospital [1][2]. The procedure is minimally invasive, requiring 4 to 5 small incisions ranging from 0.5cm to 1cm in length to access the abdomen [3]. The small incisions, or ports, allow for the insertion of trocars which act as access points into the abdominal cavity for surgical instruments and the laparoscope, or camera, that are used throughout the procedure (Figure 1) [4].

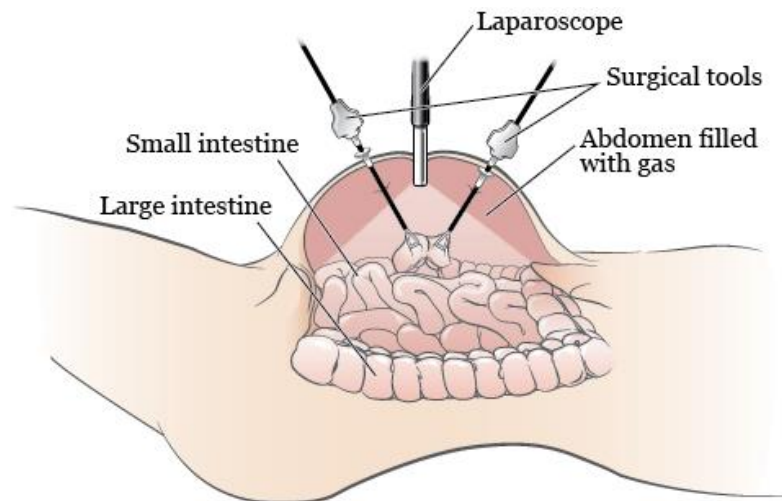

Figure 1. Diagram of laparoscopic procedure. The surgical tools are inserted through ports which act as access points for the remainder of the procedure [4].

The initial entry during laparoscopic procedures is used to inflate the peritoneal cavity to increase visibility for the remainder of the procedure. There are multiple methods for achieving this initial entry, the two most common being entry using a Veress needle and the open technique. The Veress needle is inserted into the peritoneal cavity, releases carbon dioxide to inflate the cavity, then is removed and followed by the blind insertion of a sharp trocar. The open, or Hasson technique, involves a larger incision for the trocar to be inserted immediately without prior inflation of the cavity. Both techniques are dangerous as a sharp instrument is being inserted without visualization and without a preexisting pneumoperitoneum, or presence of gas within the peritoneal cavity [5]. Since the abdomen has not been inflated, the distance between the skin surface and aorta can be as low as 2 cm, leaving little room for error during the procedure [6]. Due to the lack of visibility and low room for error, the initial insertion accounts for 33-50% of all major laparoscopic complications [7]. These complications include, but are not limited to, vascular, bowel, uterine, and bladder damage.

The Veress needle is the most commonly used technology for the initial entry into the peritoneal cavity, as it requires a smaller incision for entry. The current design of the Veress needle involves a cannula, which is an outer needle with a sharp distal point designed to penetrate the tissues, with a spring-loaded inner stylet with a dull tip intended to prevent damage when within body cavities (Figure 2).

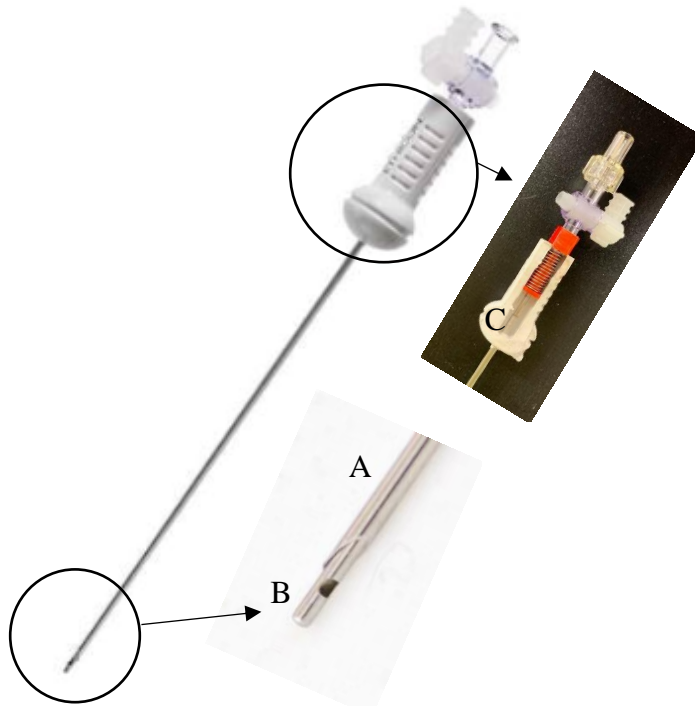

Figure 2. Current Veress needle design. (A) Outer cannula with sharp beveled tip to penetrate tissues. (B) Inner stylet with hole for release of carbon dioxide. (C) Spring in the handle to control the position of the stylet.

The problem with the current Veress needles used in the operating room involves the lack of effective components protecting the internal tissues from damage. Since the surgeon cannot see into the cavity, they must rely on feel and their experience to determine if their position in the cavity is correct; if their position is not correct and they continue with the procedure, the patient is at risk for complications. There are currently two patents available with design elements intended to alert the surgeon of their position within the cavity, eliminating the risk for complications stemming from the lack of visibility.

In a patent for a Veress needle with an illuminated tip and cavity penetration indicator, the Veress needle is designed with an external light source on the surgeon's end of the assembly to indicate whether the device is within the abdominal cavity. The light will turn off when the device has entered the cavity, as the switch is connected to the spring-loaded stylet; when the stylet is under pressure and the spring is compressed, the light will be on. When the stylet is no longer under pressure, and the spring is relaxed, the light will turn off, signaling to the surgeon that the insufflation process can safely begin [8].

The other useful patent for determining location within the cavity is a proximity detector paired with a medical instrument. The patent outlines the usage of the detector on the end of a medical instrument that determines the distance between the instrument and “an internal organ or member such as an artery” through the use of a transducer capable of sensing pressure changes [9]. While this technology was designed for use with general medical instruments, it can be adapted for use with a Veress needle to indicate the surgeon's position within the peritoneal cavity.

Neither of these patents are currently being used. The current Veress needle alerts the surgeon of their position within the cavity by either having a transparent handle, showing whether the spring is compressed, or by a red indicator that slides out of the top of the handle, indicating when the needle is under pressure.

Problem Statement

Laparoscopic procedures account for 15 million surgeries worldwide [1], with the initial entry into the peritoneal cavity accounting for 33-50% of all major laparoscopic complications [7]. This initial entry is the most dangerous as surgeons must enter the

cavity using a sharp object with no visibility and space between the outer surface of the cavity and internal tissues. **During the initial entry into the peritoneal cavity, the patients undergoing laparoscopic procedures are at a high risk for damage to internal organs and vasculature, necessitating the development of a device to protect these internal tissues and increase patient safety.**

Design Objectives

Objectives and sub-objectives were established for the device (Table 1). To determine which objectives were critical to the design of our device, we considered what the currently technology achieves successfully, as well as where it falls short. Since the current technology results in operator mistakes that may lead to patient complications, the main objectives of our device were determined to be safe, user friendly, and marketable.

Table 1. Objectives and sub-objectives established prior to designing the device.

Objective	Sub-Objective
Safe	Biocompatible
	No risk of organ damage
	Minimally Invasive
User Friendly	Handheld
	Easy to Operate
Marketable	Low Cost
	Time Efficient

We decided that for a safe device to be created, the product must be biocompatible, allow for minimal organ damage, and maintain the minimally invasive nature of the current

laparoscopic procedure. The current techniques result in organ damage if not used properly, so the device needs to improve upon the safety of the procedure without becoming a more invasive procedure.

To produce a device that is user friendly, we determined that the device needs to be easy to operate to prevent operator mistakes, as well as handheld. We need to create a device that does not change the procedure for the surgeons and can be operated using one hand.

Finally, we believed our third objective, producing an instrument that would be marketable, could be achieved by creating a device that was low cost and time efficient. If our new device is not comparable in price and efficiency to the current products on the market, surgeons will be unlikely to switch to our device, even if it is safer.

Device Functions and Specifications

Based on current technologies and our design objectives, the main functions of our device can be split into two categories: achieves pneumoperitoneum and increases patient safety. To achieve pneumoperitoneum, we determined our device functions to be as follows: cuts through outer abdominal wall efficiently, enters through a small incision, and inflates the peritoneal cavity (Table 2). To increase patient safety, we determined the functions of our device to be as follows: provides buffer to prevent organ damage, maintains the same procedure for the surgeons, and safely removes buffer (Table 2). For every function our device must fulfill, we determined a corresponding metric to determine the degree to which the device will complete the function requirement.

Table 2. Device functions and corresponding specification values.

Category	Function	Metric	Unit	Margin al Value	Ideal Value
Achieves Pneumoperitoneum	Cuts through abdominal wall	Force required for entry	Newtons (N)	68.67 [10]	68.67 [10]
Achieves Pneumoperitoneum	Enters through small incision	Size of incision	Millimeters (mm)	12 [11]	10 [11]
Achieves Pneumoperitoneum	Inflates the cavity	Presence of port	Binary yes or no		
Increases Safety	Provides buffer to protect organs	Presence of buffer component	Binary yes or no		
Increases Safety	Maintains procedure	Alters procedure methods	Binary yes or no		
Increases Safety	Removes buffer	Force required for buffer removal	Newtons (N)	1 N Less than removal force for current model	3N Less than removal force for current model.

Our design must complete a number of functions in order to compete with the current Veress needles and solve the problem we have identified. As the initial entry process is carried out, the device must first be able to penetrate the multiple layers of abdominal tissue under the average pressure that surgeons currently apply. The force generally

applied by a surgeon to penetrate the tissues is 68.67N [10]. We do not want to alter the force required because this method has become routine. Although our design ideally will give the surgeon the ability to apply a greater force while still not damaging the inner tissues, the transition to using our device should be simple and we want the process to feel the same for the surgeon.

The device must also fit through a single small incision. Laparoscopic procedures begin by making a 12mm incision with a scalpel to put the Veress needle through [11]. Our device needs to be small enough to fit through that same incision; we must keep the cannula portion of the device small enough that this specification will not change.

Next, we want a buffer to deploy to protect the inner tissues. This function is binary: either the buffer will deploy or it will not.

Then, once safely positioned inside the cavity, the device must act like port to allow for the flow of carbon dioxide to inflate the peritoneal cavity. This function is also binary, as the device will either allow for the passage of carbon dioxide or it will not.

Finally, our device must be able to remove the buffer in order to safely exit the body. The buffer must come off the device to ensure safe removal with a force less than or equal to the average force required for current model removal. The specification for these values were determined during validation testing.

Design Requirements

The most important requirements for our design were determined based on our objectives and functions, stemming from research and current models. The top requirements for our

device were as follows: must cut through tissues, must inflate the peritoneal cavity, requires a small incision for entry, and must have a buffer component (Table 3). The requirements were all determined with associated specification values that will serve as a baseline for our evaluations.

Table 3. Design requirements and specifications.

Design Requirements	Specification
Penetrates through tissues	68.67 N [10]
Provides port or cavity inflation	Binary (port presence)
Device size	12 mm midline incision [11]
Buffer component	Can withstand 68.67 N of entry force [10]
Protects internal tissue	Binary
Buffer withdrawal force	To be determined through testing - must be less than average force of the current model in order to ensure the buffer “pops” off

The three critical components of our design that must be at least equivalent to the current design of a Veress needle are its ability to cut through tissues, inflate the peritoneal cavity, and do so through a small incision. The device must cut through tissues when a force of no greater than 68.67N is applied [10], inflate the cavity successfully which is indicated by the presence of carbon dioxide in the cavity, and the device must be inserted through an incision no larger than 12mm [11]. These design requirements are

successfully fulfilled by the current Veress needle models and are crucial to the procedure.

To improve the current Veress needle, we added the requirements of a buffer component to protect the internal organs. This requirement stems from our objective of safety and addresses the main problem with the current Veress needle models of unwanted injury to inner structures. The buffer component must withstand the force of 68.67N and continue to protect the internal tissues when this force is applied [10]. In order for our design to function, the buffer must “pop” off the end of the device upon removal of the inner stylet. The buffer must come off of the stylet easily, with less force than is required for standard device removal. We will determine what force is required to remove a Veress needle from the body and compare this value to the force required for the buffer to come off the stylet to ensure it is less.

These design requirements will be thoroughly evaluated individually to ensure the success of our device.

Proposed Design

Pictured below is a 3D model and dimensional drawing of the final design of our prototype created with SolidWorks. The length of the cannula is 160mm and the diameter of the buffer is 6.35mm (Figure 3).

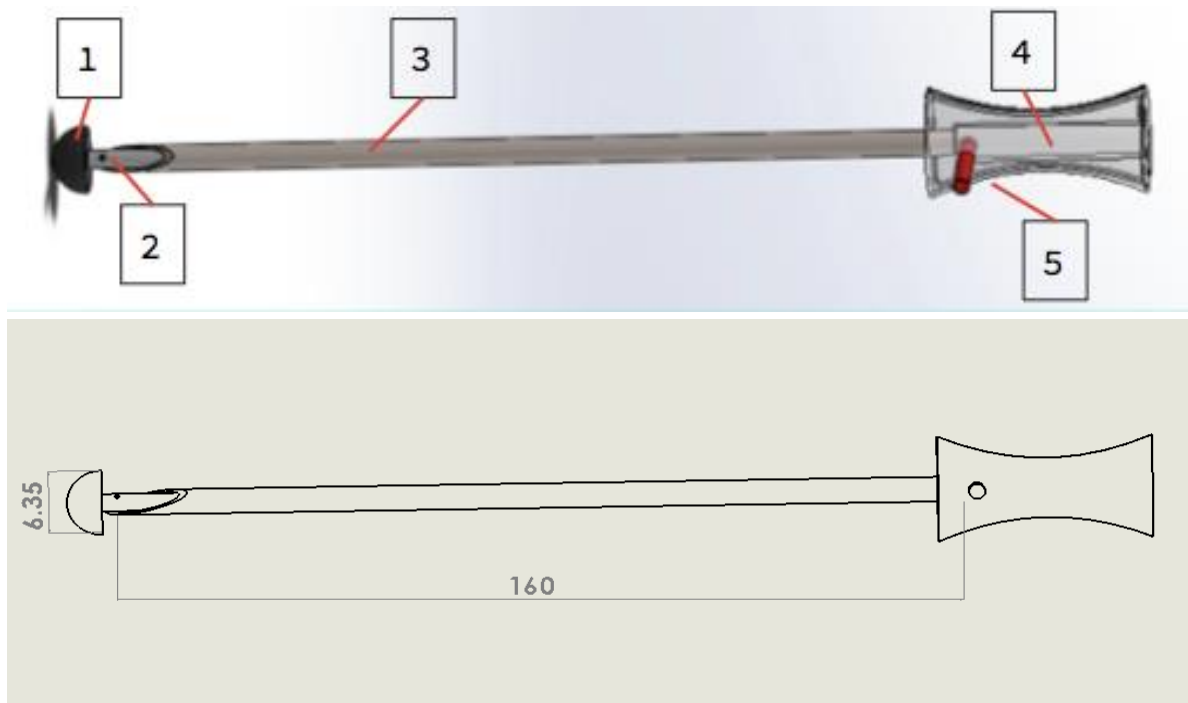

Figure 3. (Top) SolidWorks model of final design showing protective buffer (1), stylet with air port (2), sharp outer cannula (3), spring loaded handle (4), and pin for stylet/buffer retraction (5). (Bottom) Dimensional drawing of final design with buffer diameter and length of cannula noted in millimeters.

Entry and Insufflation

The buffer is attached at the end of the stylet and will begin inside of the cannula's shaft, as the sharp beveled tip of the cannula pierces through tissues prior to the abdominal cavity. As this occurs, the end of the stylet will be under pressure by a spring located inside of the handle. Once the tip of the needle reaches the open space inside of the abdomen, the spring in the handle will force the stylet/buffer combination out of the cannula. The buffer will then expand, so that it is extended around the entirety of the sharp cannula's outer surface, thus protecting the internal tissues of the patient from

contact with the sharp tip of the needle. Once the tip of the needle is inside the patient's abdominal cavity, air will be pumped from the handle-end of the stylet, travel through the hollow stylet, through an air port, and into the cavity of the patient, allowing for the successful insufflation necessary for the laparoscopic procedure.

Retraction of Stylet Prior to Entry

An issue with the rounded dome buffer component that we designed was that since the diameter of the buffer is larger than that of the cannula, once it is deployed out of the cannula, it will not be easily retracted back into the cannula. In order to account for this, a handle was designed and manufactured from PLA that contained a pin to keep the buffer/stylet component inside of the cannula prior to becoming in contact with the exterior tissues of the patient (Figure 4).

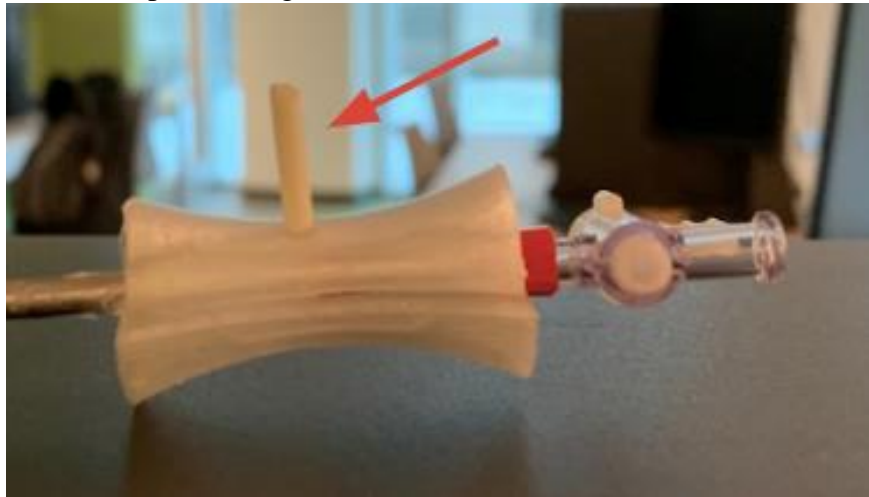

Figure 4. Handle of prototype, containing a pin to keep the stylet and buffer component retracted (shown by red arrow) prior to the tip of the needle coming in contact with external tissues of patient.

The pin seen above keeps the spring inside of the handle compressed, and thus the stylet connected to it inside of the shaft of the cannula. This pin serves as a way to prevent premature buffer deployment. Upon contact between the external tissues of the patient and the tip of the needle, the pin will keep the buffer/stylet component retracted. Once the

tip of the needle comes in contact with the patient's external tissues, the pin will be removed, as the external tissues of the patient will be preventing deployment of the buffer. Upon entry into the abdominal cavity, the pressure that was exerted upon the tip of the needle, keeping the buffer component inside of the cannula, will no longer be present. This will allow for the buffer to be released into the cavity, encompassing the sharp cannula's outer surface, and thus protecting the patient's internal tissues.

Removal of Needle

Once the buffer has been deployed, and the abdominal cavity has been successfully insufflated, the needle will need to be removed. Due to the greater diameter of the buffer than the cannula, the needle cannot be taken out of the abdomen of the patient all at once. To account for this, the handle was made in two pieces that snap into one another and can be separated upon successful insufflation (Figure 5).

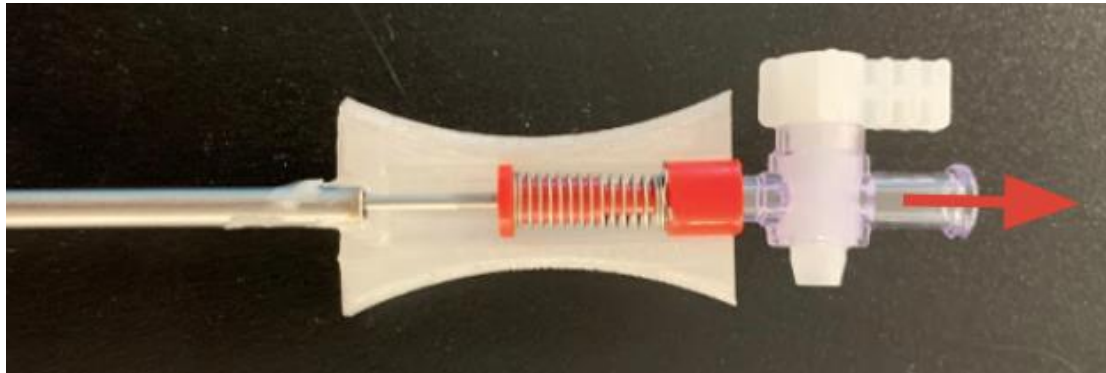

Figure 5. Prototype showing handle opened up, allowing for removal of stylet component. Red arrow shows direction of pulling done by user to remove stylet component.

Once the cavity has been inflated, the top of the handle of our device will be removed. This will allow for the stylet to be pulled through the cannula, and thus out of the body of the patient. In doing so, the buffer component will be forced off of the end of the stylet and will remain inside the patient's body. To ensure the patient's safety, the buffer

component will be fabricated from a biodegradable material that exhibits the necessary flexibility and durability of our buffer component. Once the buffer has been removed from the stylet and the stylet has been removed from the patient, the cannula can easily be taken out of the cavity, in a traditional needle fashion.

Final Prototype

Our final prototype combined all of these components (Figure 6). The prototype was fabricated out of stainless steel for the cannula, PLA for the handle, and Repro Rubber for the buffer. The buffer was created using a dome mold that the Repro Rubber was poured into, which resulted in the flexible but durable buffer prototype. We used the stylet and spring component from a current Veress needle.



Figure 6. Final prototype iteration. The buffer (1), stylet (2), cannula (3), spring (4), and handle (5) fit together to create a working prototype. The handle is shown in a cross sectional view.

Validation of Design

Based on our top design requirements of cutting through tissues, inflating the peritoneal cavity, requiring a small incision for entry, having a buffer component that protects the internal tissues, and having the buffer safely exit the body, we developed corresponding evaluation methods to ensure completion of these requirements (Table 4).

Table 4. Evaluation methods for top five design requirements.

Design Requirements	Specification	Evaluation
Cuts through tissues	3 attempts	Use practice tissue to determine ease of access
Inflates cavity	Binary	Open the valve and blow through the port to ensure the buffer does not prevent air flow
Device size	12 mm midline incision [11]	Cut a standard incision for laparoscopic surgery in practice tissue to ensure that the device fits inside
Buffer component	68.67 N or 15.44 lbs [10]	Use practice tissue to ensure that the buffer prevents the cannula from puncturing tissues. Use scale to determine if the buffer can handle the standard force.
Buffer safely exits the body	TBD – the force required to remove needle from body	Ensure that the buffer component does not break off when this force is applied.

A practice tissue was used to test the device's ability to cut through tissue and the device's size. To test the device's ability to cut through the tissue, we created the 'Hot Glue Test'. For the hot glue test, we put hot glue on a piece of paper and then placed the practice tissue on top. We then pierced through the practice tissue with the cannula without applying excessive force for fifteen trials. After each trial, we removed the practice tissue and checked the hot glue for a clear puncture mark. If there was a mark in the glue, the trial was considered successful. We successfully pierced through the tissues on the first attempt for all trials; therefore, our device meets the requirement of piercing through the tissues within three attempts.

Since we did not change any of the insufflation mechanisms, validating that our device inflated the cavity was binary; we tested to see if it allowed for air flow or if the buffer prevented air flow. To test this, we opened the valve attached to the handle and blew through the handle where the carbon dioxide would be hooked up. With the buffer attached, our device allowed for air flow.

To ensure that our device maintained the minimally invasive nature of the procedure, our device had to fit through a 12mm incision. To test this, we made a 12mm incision in practice tissue and inserted our device. Since the diameter of our cannula was 4mm, it fit through the 12mm incision with ease.

To verify that our buffer successfully protected the tissues, we performed the 'Hot Glue Test' with the buffer encompassing the cannula. The buffer was successful in preventing puncturing for all fifteen trials. Following this test, we tested to ensure that the buffer could handle the standard force applied during laparoscopic initial entry, which is 68.67N. To test this, we pushed our device with the buffer attached into a scale until the scale began to give inaccurate results. This value was 15.6lbs which can be converted to 69.4N. Since this value is greater than the 68.67N applied during surgery, we concluded that our buffer would successfully prevent the cannula from puncturing tissues.

Since our buffer is designed to pop off of the stylet upon removal from the body, we tested to ensure that it would not require excessive force during removal. The first step in this test was to remove the Veress needle from practice tissue using a force gauge to determine the average force required to remove the needle from the tissues. The needle was removed five times by each of us for a total of fifteen trials resulting in an average

removal force of 3.5N. To ensure that the buffer popped off of the stylet without exceeding this 3.5N force, we used the force gauge to pull the stylet up against the cannula until the buffer popped off. We had a total of fifteen trials resulting in an average force of 1.1N. Since the buffer popped off at a force less than 3.5N, we concluded that the buffer will be safely popped off of the stylet during removal without the need to apply extra force.

Since we did not alter the main mechanisms of the device, the overall procedure was not altered significantly. However, we wanted to ensure that the weight of the device was not altered significantly, as that would affect the force required to successfully complete the procedure. We weighed the current Veress needle, which was found to be 0.02lbs. According to the literature, a Veress needle should weigh less than 4lbs [12]. Our completed prototype was found to weigh 0.03lbs, which is within the specification range, so we determined this would not affect the procedure significantly.

Anticipated Regulatory Pathway

If we were to take this project further and go through the process of attempting to get FDA approval, we would go the route of the 510(k) premarket notification similarly to the GRI-Alleset Veress needle. The GRI-Alleset Veress needle 510(k) premarket notification was filed by GRI Medical and Electronic Technology Co., Ltd., 1805 Honggao Road, Xiuzhou Industry Zone, Jiaxing, China 214031 under the 510(k) number K172835. The device was filed with product code HIF (insufflator, laparoscopic) with a common name of Veress Needle and regulation name of Laparoscopic insufflator. The regulation number of the device was 21 CFR 884.1730 and it was classified as a class II device. The device was reviewed by the Obstetrics and Gynecology panel [13].

The GRI-Alleset Veress needle was found to be substantially equivalent to the Endopath Ultra Veress needle produced by Ethicon Endosurgery, Inc. Both devices are Class II laparoscopic insufflators intended to be used by surgeons in the operating room. The results of the performance testing determined that the GRI-Alleset Veress Needle is substantially equivalent to the Ethicon Endopath Ultra Veress Needle. Mechanical bench testing involving gas flow, leakage, max puncture force, rotational valve operation, stylet alignment, stylet strength, connector fitting, and audible rate were conducted and found to be equivalent to the predicate device.

The GRI-Alleset Veress needle is similar to our device as it's intended use is as a "disposable, single-use, sterile surgical instrument used during minimally invasive surgery for the establishment of peritoneum of the abdominal cavity prior to abdominal surgery." Both devices include a stainless-steel needle with a spring-loaded inner stylet attached to a plastic handle with a red safety indicator. Where our devices differ is in our added buffer component that we intend to leave in the body following the procedure. This added element may add complications to our FDA approval route in comparison to similar devices.

References

- [1] N. S. Blencowe, R. Waldon and M. N. Vipond, "Management of patients after laparoscopic procedures," *BMJ*, p. 360, 08 February 2018.
- [2] J. Fouogue, R. Tchounzou and F. Fouelifack, "Evaluation of patients' satisfaction after laparoscopic surgery in a tertiary hospital in Cameroon (Africa)," *The Pan African Medical Journal*, vol. 28, no. 216, 2017.
- [3] B. S. M. Chern, S. Lakhotia, C. Kiat Khoo and A. Yew Ming Siow, "Single incision laparoscopic surgery in gynecology: Evolution, current trends, and future perspectives," *Gynecology and Minimally Invasive Therapy*, vol. 1, no. 1, pp. 9-18, 2012.
- [4] Memorial Sloan Kettering Cancer Center, "Diagnostic Laparoscopy: About Your Diagnostic Laparoscopy," *mskcc.org*, Aug. 30, 2016.
- [5] T. Vellinga, S. De Alwis, Y. Suzuki and J. Einarsson, "Laparoscopic Entry: The Modified Alwis Method and More," *Reviews in Obstetrics and Gynecology*, vol. 2, no. 3, pp. 193-198, 2009.
- [6] A. Toro, M. Mannino, G. Cappello, A. Di Stefano and I. Di Carlo, "Comparison of Two Entry Methods for Laparoscopic Port Entry: Technical Point of View," *Diagnostic and Therapeutic Endoscopy*, p. 7, 2012.
- [7] S. Krishnakumar and P. Tambe, "Entry complications in laparoscopic surgery," *US National Library of Medicine National Institutes of Health*, 2009.
- [8] R. Mohajer, "Veress needle with illuminated tip and cavity penetration indicator," U. S. Grant 8838206B2, 16 Sep., 2014.
- [9] R. Marks, C. Edwards, "Proximity detector with a medical instrument," U. S. Grant 5080104A, 14 Jan., 1992
- [10] The Center for Innovative GYN Care, *Laparoscopic Procedure*, 2018.
- [11] M. Perrin and A. Fletcher, "Laparoscopic abdominal surgery," *Continuing Education in Anaesthesia Critical Care and Pain*, vol. 4, no. 4, pp. 107-110, 2004.
- [12] G. A. Vilos, A. Ternamian, J. Dempster and P. Laberge, "Laparoscopic Entry: A Review of Techniques, Technologies, and Complications," *SOGC Clinical Practice Guideline*, vol. 193, pp. 433-447, 2007.
- [13] GRI Medical And Electronic Technology Co., Ltd, "GRI-Alleset Veress Needle," 510(K) Number K172835, 19 Sept., 2017

Appendix A: Current Patents

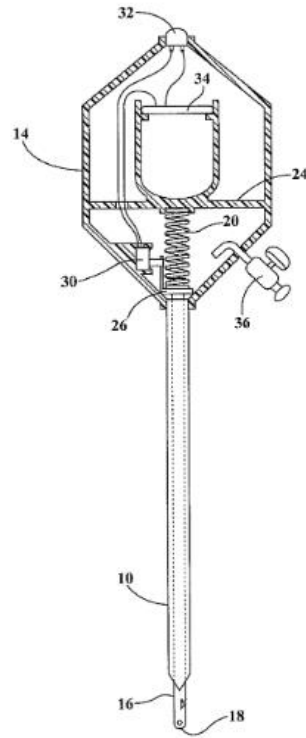

Figure A-1. Diagram of patent with an indicator light (32) switched on by the positioning of the spring (20) which triggers the switch (30) [9]

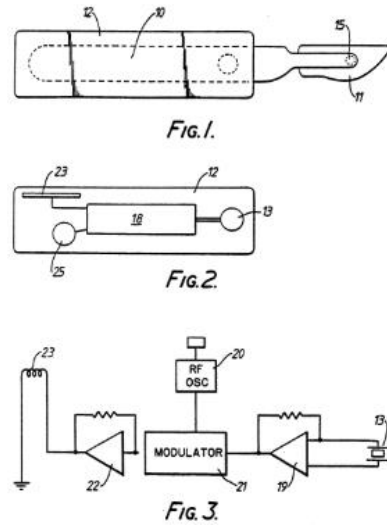

Figure A-2. Diagrammatic illustration of a surgeon's scalpel in a holder with a miniature acoustic transducer, with an expanded view of the electronic circuit [10]

Appendix B: Objective and Sub-Objective Trees

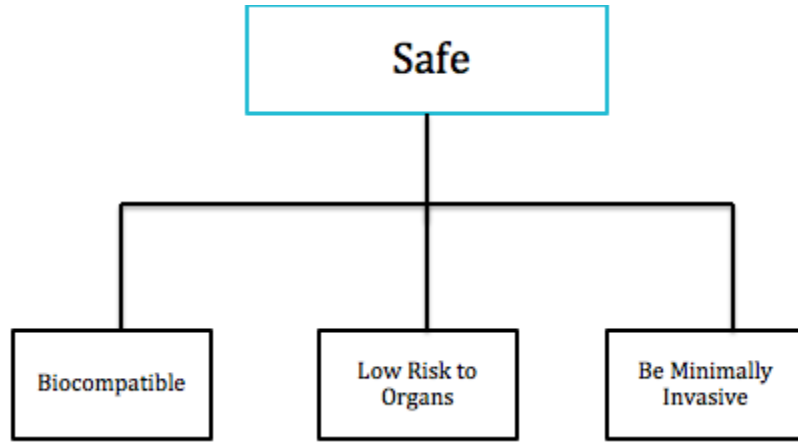

Figure B-1. Objective tree for sub-objectives relating to the main function of safe.

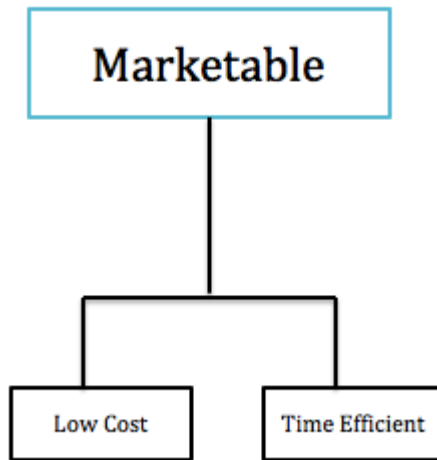

Figure B-2. Objective tree for sub-objectives relating to the main function of marketable.

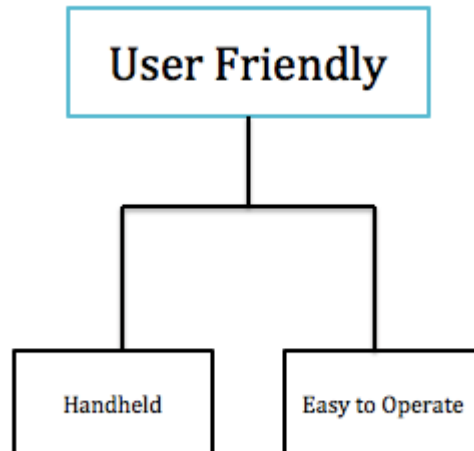

Figure B-3. Objective tree for sub-objectives relating to the main function of user friendly.

Appendix C: Decision Matrices

Objectives	Baseline	Ultrasonic	Guide	Suction	Pressure Sensor	Laser	Hand	Umbrella	Screw
	Rating	Rating	Rating	Rating	Rating	Rating	Rating	Rating	Rating
Biocompatible	0	NA	NA	NA	NA	NA	NA	NA	NA
Easy to operate	0	+	+	0	0	0	+	0	-
Minimally invasive	0	0	0	0	0	0	0	0	-
Low risk of organ damage	0	+	+	+	+	+	-	+	+
Time efficient	0	+	-	0	0	0	+	+	-
Handheld	0	0	-	0	0	0	+	0	0
Feasible	0	0	0	0	0	-	-	0	-
Low cost	0	-	-	-	-	-	-	-	-
TOTAL	0	2	-1	0	0	-1	0	1	-4

Figure C-1. Screening decision matrix. All of the potential designs were evaluated based on their satisfaction of the objectives. Any design that did not reduce the risk of organ damage were immediately eliminated. The top choice was the design incorporating ultrasonic proximity sensors.

Objectives	Weight	Ultrasonic		Umbrella		Suction		Ultrasonic/Umbrella	
		Rating	Weighted Score	Rating	Weighted Score	Rating	Weighted Score	Rating	Weighted Score
Biocompatible	-	-	-	-	-	-	-	-	-
Easy to Operate	0.08	4	0.32	4	0.32	3	0.24	5	0.4
Minimally Invasive	0.2	3	0.6	3	0.6	2	0.4	3	0.6
Low risk of organ damage	0.3	3	0.9	4	1.2	3	0.9	5	1.5
Time Efficient	0.06	3	0.18	3	0.18	2	0.12	3	0.18
Handheld	0.06	5	0.3	5	0.3	3	0.18	5	0.3
Feasible	0.21	3	0.63	4	0.84	3	0.63	3	0.63
Low cost	0.09	3	0.27	4	0.36	3	0.27	3	0.27
TOTAL	1	x	3.2	x	3.8	x	2.74	x	3.88
Rank			3		2		4		1

Figure C-2. Weighted decision matrix. The top designs determined by the screening matrix were weighted based on their satisfaction of the objectives. The top design was the design combining the elements from the umbrella and the ultrasonic proximity sensor.

Appendix D: Other Designs Not Developed Further

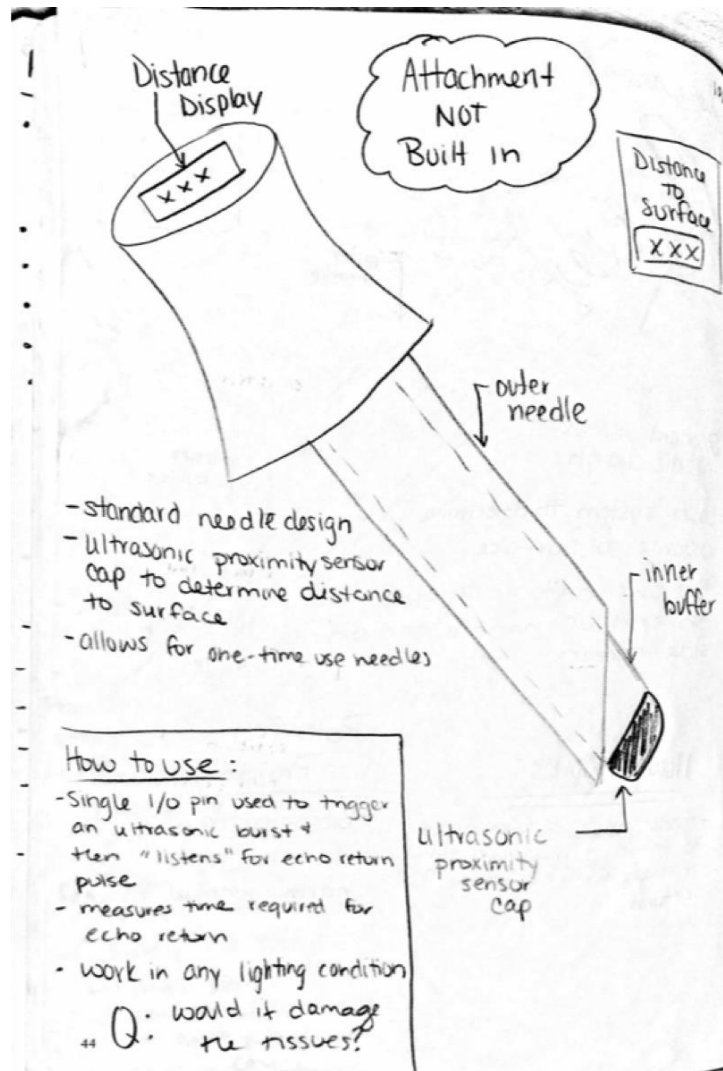

Figure D-1. Peritoneal cavity entry device concept design, incorporating an ultrasonic proximity sensor. Design was determined to not be feasible for the scope of our project.

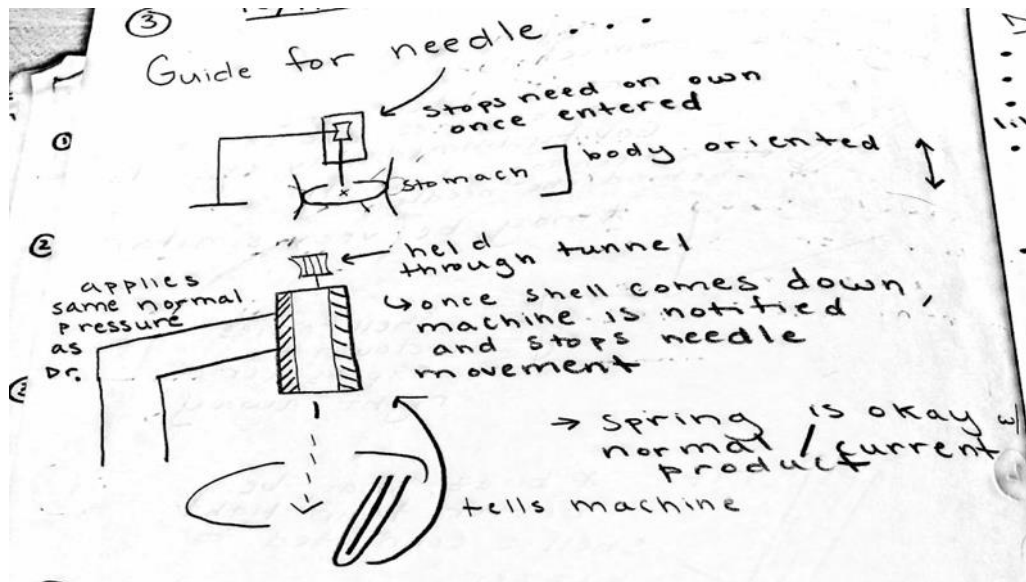

Figure D-2. Peritoneal cavity entry device concept design incorporating large guide, reducing the potential for human error. Design was determined to not be user friendly for the surgeon.

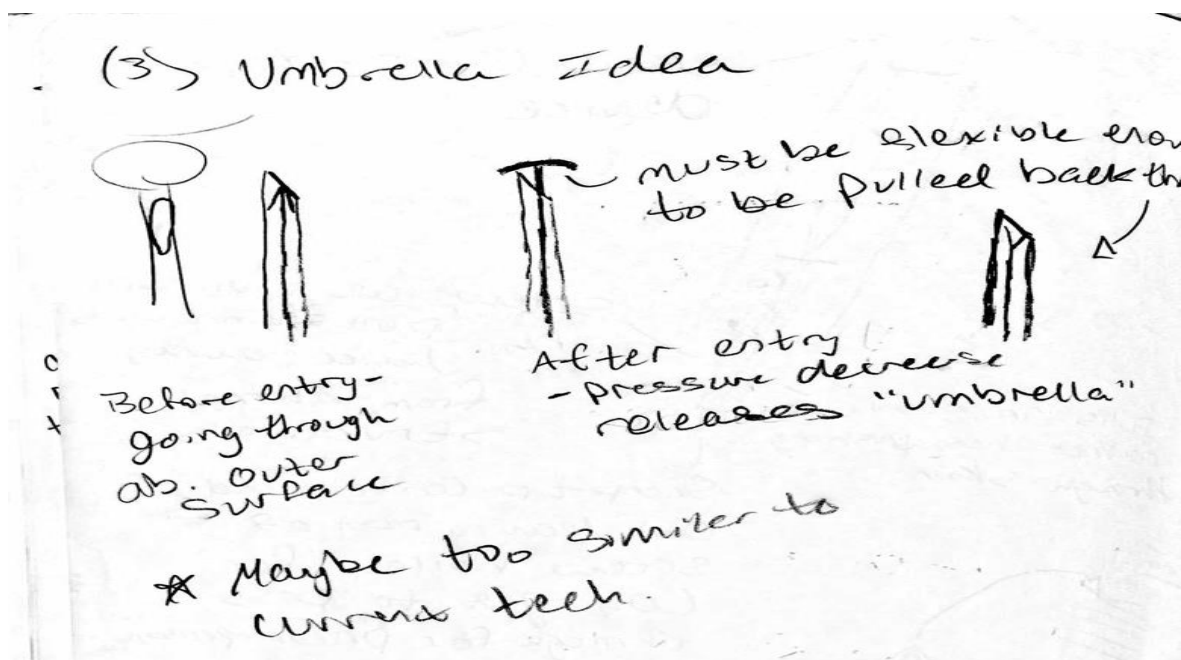

Figure D-3. Peritoneal cavity entry device concept design that the final design we agreed upon was developed from. Incorporates a buffer between the sharp cannula and the internal tissues.

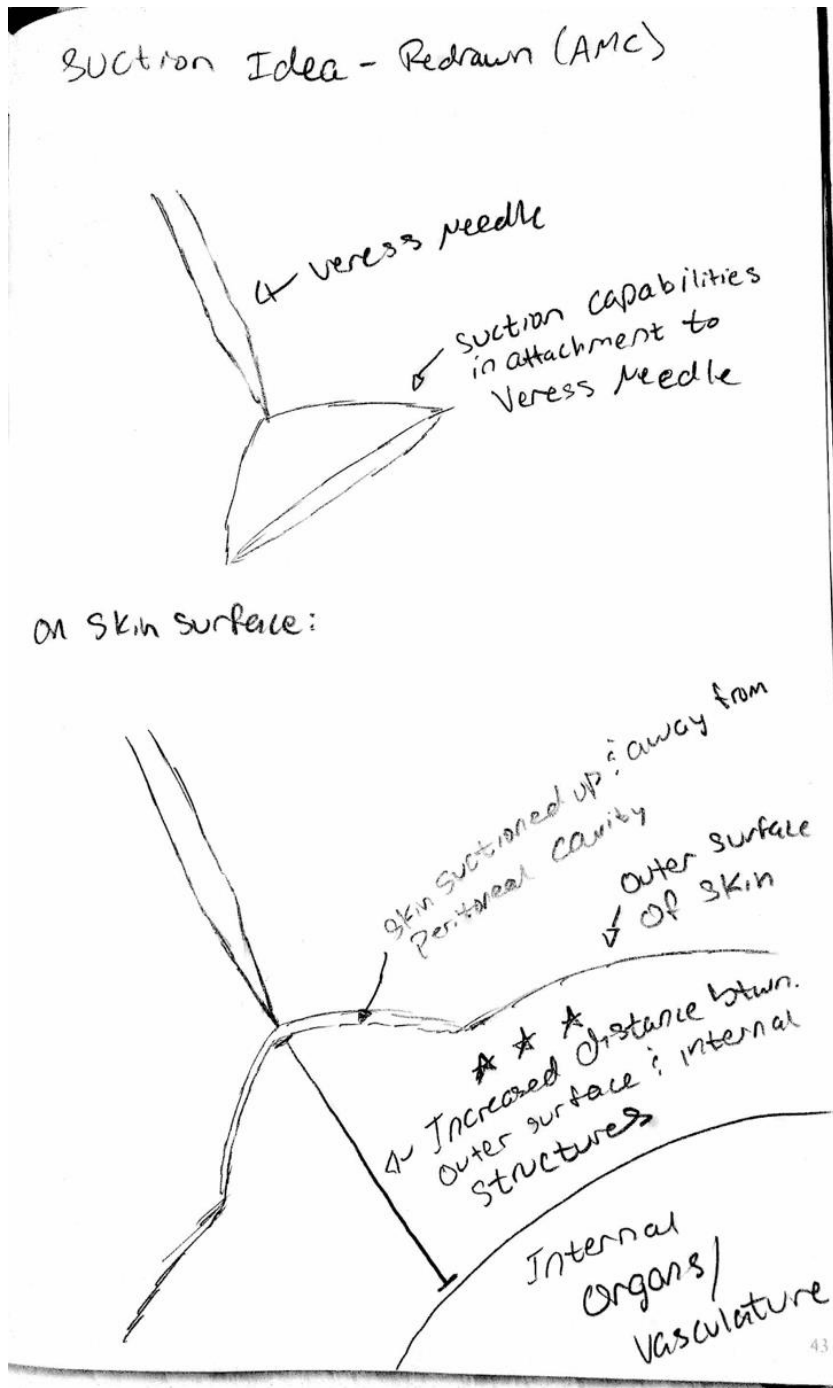

Figure D-4. Peritoneal cavity entry device concept design incorporating a suctioning technique. A device on the market was identified as already utilizing this technique, and therefore the device was determined to be an infringement upon IP.

D-3